

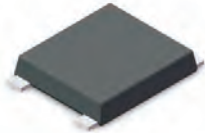

: 5 / 6 % 0

129

8OWUDVRIW 5HFRYHU\ %ULGJH



/6% 3DFNDJH

3,11,1*

3,1	'(6&5,37,21
	,QSXWÄÄ Q
	,QSXWÄÄ Q
	2XWSXWÄÄ Q RGH
	2XWSXWÄÄ W KRGH

)HDWXUHV

‡*ODV D VVLY & W L X G F W L R Q

‡5HYHUVH 9 R 0 W D J H 9

‡)RUZDUG U H G \$ W

‡+LJXU & X U U & H Q S V D E L O L W \

‡'HVLJQRG X U I D R X \$ \$ S O L F D W L R Q

%HQHILWV

‡ & D V H %

‡7HUPLEBROGHUBB,0H67'

‡5HGXFHG (0, 5HGXFHG SRZHU

DQG VZLWFKLQJ WUDQVLYW

0D[LPXP DWL Q Q G O H F W E K B D O F W H U L V W L F V

5DWLQVf & DP EL MGHV SHUXDQXUMK H U Z L H F L I L H G

6LQJOH SKDVH K Q I H Z D Y H U Q G X F O R D Y H S D F L W E X H U G R D G W H

3DUDPHWHU	6\PEROV	:5/6% 0	8QLWV
0D[LPXP 5HSHWLWLYH 3HDN 59550U	VH 9ROWDJH		9
0D[LPXP 506 YROWDJH	9506		9
0D[LPXP '& %ORFNLQJ 9ROWDJH &			9
\$YHUDJH 5HFWLILHG 2XWSXW & RUUHQW			\$
5HYHUVH 5HFRYHU\ 7LPH ,) \$,5 \$,55 \$	7UU		XV
3HDN)RUZDUG 6XUJH & XUUHQW +DOI 6LQH :DYH 6XSHULPSRV, H60 R Q 5DWHG /RDG -('(& 0HWKRG		PV 6LQJOH	\$
, WUDWIRQXVLQBV W PV	, W		\$ 6
0D[LPX)RUZDUG WDW H \$	9)		9
0D[LPXP '& 5HYHUVH & XUUHQW #7\$ DW 5DWHG '& %ORFNLQJ 9ROWDJH #7\$	f & f &		\$
7\SLFDO -XQFWLRQ & R D V D F L W D Q M H			S)
2SHUDWLQJ DQG 6WRUDJH 7HPSW W D W X U H 5 D Q J H a			f &
7\SLFDO WKHUPDO UHVLVWDQJ 5WK 1 \$	5WK 1 \$		f & :
1RWH0HDVX D M G +] D Q G S S O L H H Y R O G W R D J H & 0RXQWHG RQ JODVV HSR\ 3 & ERDUG ZLWFRSSHU SDG			

: 5 / 6 % 05HY

:RUOG ,QWH&JUDMLFLQDHOG

RATINGS AND CHARACTERISTICS CURVES 7\$ ° & XQOHVV RWKHUZZLVH QRWHG



Capacitance (pF)

7 F & DVH 7&HPS

Reverse Voltage (V)

3 \$ & . \$ * (287 / , 1 (' , 0 (16 , 2 16

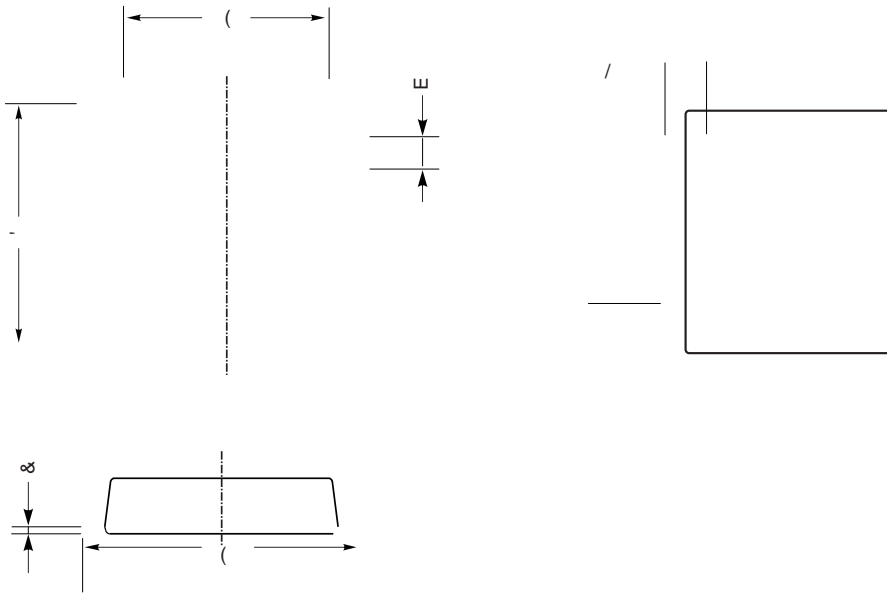

/ 6 % P H F K D Q G L F W D

8 1 , 7		\$	&	'	(&	/	H	E
PP	PD[
	PLQ								
PLO	PD[
	PLQ								

/ 6 % 6 X J J H V W H G 3 D G / D \ R X W

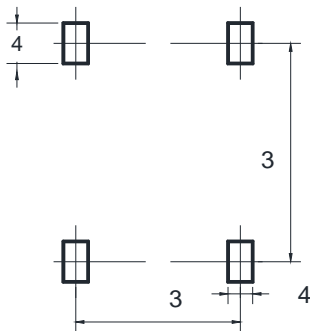

8 1 , 7		3	3	4	4
PP	PLQ				
PLO	PLQ				

' L P H Q V I L R / Q R / L O O L P H W H U V



: 5 / 6 % 0

0DUNLQJ ,QIRUPDWLRQ

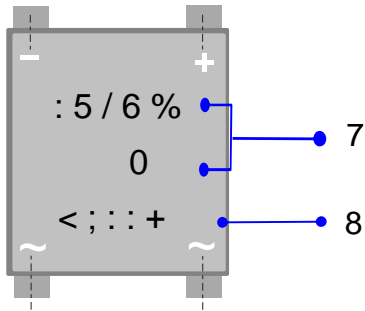

73URGXFW P5R 6% 00
83' & LQIRUPDWLRQ

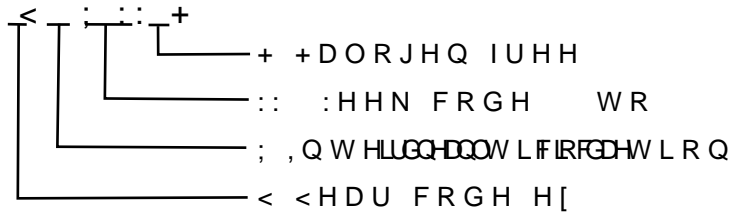

3DFNDJLQJ ,QIRUPDWLRQ

5HHO 'LPHQVLRQV

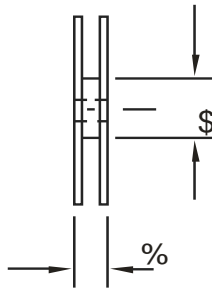
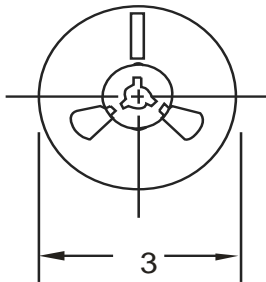

,QVLGH %R[

2XWVLGH %R[

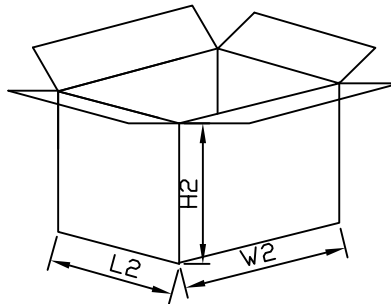
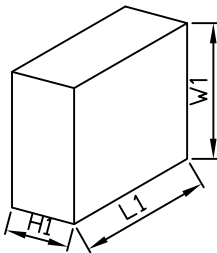

3DFNDJLQJ ,QIRUPDWLRQ

12	81,	5HHO 'LPHQVLR			,QVLGH %R[2XWVLGH %R[
6L]H	PP	&	\$	%	/	:	+	/	:	+
47<	3&6	6PDOGSDVFDJH3&6 UHHO			3&6 UHHO RWDO			3&6 FDUERPRQ RWDO		
1RWH		7ROHUDQFPP" PP			PP" PP			PP" PP		